

Hydrosplit-M3

Heat/cooling calculator, separated version

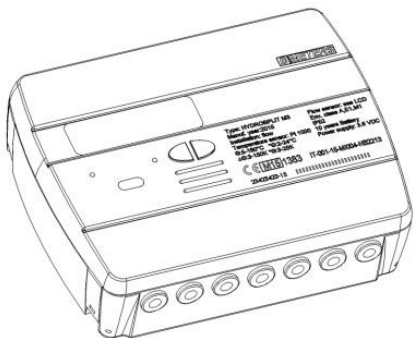

EN 1434

USER MANUAL

Premise

The installation must be carried out by qualified personnel only. The manufacturer doesn't assume any responsibility for improper installation or damages caused by third parties.

Warning

The calculator contains potentially dangerous batteries: handle carefully and do not dump in the environment.

INTRODUCTION

The model Hydrosplit-M3 is a separate electronic calculator that measures the thermal energy used in the heating and cooling systems.

The calculator allows the simultaneous calculation of:

- Thermal energy in a heating/cooling system.
- Volume up to 2 flow meters for hot and cold sanitary water.

The calculator is equipped with two pulse emitter outputs (one for the heating data and one for the cooling data) and one output for the Wired M-Bus network link.

PACKAGE CONTENTS

- Hydrosplit-M3 calculator
- Mounting bracket
- Wall mounting screws
- User manual
- Adhesive seal

GENERAL INFORMATION

- Before proceeding with the installation and configuration of the product, read carefully the instructions described in this manual. For further technical questions, please contact Technical Support.
- The installation must be carried out by qualified personnel only.
- The relevant regulations regarding the instrument are the EN1434 (1-6) and Directive 2004/22/CE (Annex MI-004).
- Any tampering of the calculator or removal of the seals will void the warranty provided.
- For proper energy accounting, it is strictly mandatory that the flow meter and the calculator have the same pulse value.

INSTALLATION

CALCULATION UNIT

Open the calculation unit by leveraging on the four hooks on the sides [1] and remove the cover [2].

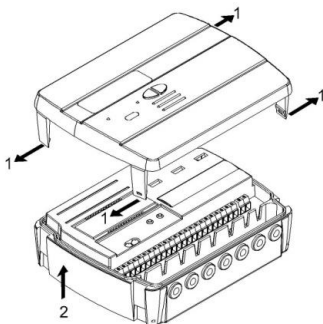

Remove the bracket behind the calculation unit and secure it to the wall. There are two types of wall mounting allowed:

- 1) direct wall mounting by using the mounting bracket and the following hooking of the calculation unit on the same bracket;
- 2) by wall mounting of a Din Rail and following hooking of the mounting bracket (see pictures below).

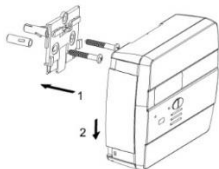

Case 1

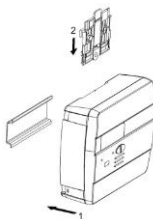

Case 2

Then apply the basis on the bracket and secure it with any anti-removal seals.

After the installation, connection, configuration and commissioning, close the cover and apply adhesives and / or lead sealings.

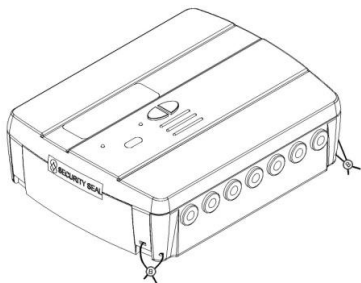

TEMPERATURE SENSORS INSTALLATION

For the temperature sensors installation, see related manual.

FLOW METERS INSTALLATION

For the flow meters installation, see related manual.

COMPONENTS CONNECTIONS

The flow/volume meters, temperature sensors, M-Bus network etc. should be connected on the terminal board inside the calculator.

Tighten all the terminals carefully, making sure that the connections are completely secure.

Warning: Be careful when entering cables into the terminal in order to avoid potential malfunctioning caused by the contact between the sheath and clamp.

TERMINAL BOARD DESCRIPTION

1	5	6	2	3	7	8	4	10	11	50	51	52	53	54	55	56	57	58	16	17	24	25	59	60
forward flow		return flow		flow IN		C1 IN		C2 IN		cold OUT		hot OUT		MBUS		Aux Power								
↑		↑		↑		↑		↑		↓		↓		↑↓		↑								

Numbers	Indication	Description
1/5/6/2	Forward flow	Inlet temperature sensor
3/7/8/4	Return flow	return temperature sensor
10/11/50	Flow IN	Flow meter input
51/52/53	C1 IN	Volume meter input 1
54/55/56	C2 IN	Volume meter input 1
57/58	Cold OUT	Cooling pulse output
16/17	Hot OUT	Heating pulse output
24/25	MBUS	M-Bus network connection
59/60	Aux Power	Power supply connection

TEMPERATURE SENSORS CONNECTION

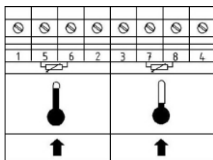

- Connect the inlet temperature sensor in the terminals 5 and 6;
- Connect the return temperature sensor in the terminals 7 and 8;

Warning: To avoid errors in the energy calculation, respect the correspondence between the inlet and

return temperature sensors and the respective terminals. Use PT1000 temperature sensors only, EN1434-2 MID (2004/22/CE) approved.

FLOW METER CONNECTION

Connect the flow meter for thermal energy metering in the pulse input “flow in” (10,11,50).

The calculation unit is compatible with flowmeters with pulse output OC (open collector) or OA (reed), with pulse value “liters/pulse” (strictly compliant to the value set on the calculator).

Terminal 50 is reserved for eventual Anti-tampering wire connection.

Warning: in case of fiscal energy metering, it is mandatory to connect flow meters EN1434 approved.

Warning: when using flow meters with Open-Collector (OC) output, it is necessary to follow the correct connection polarity.

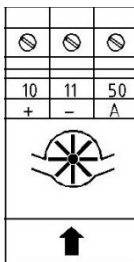











VOLUME METERS C1/C2IN CONNECTION

The inputs C1 IN (51, 52, 53) and C2 IN (54, 55, 56) are dedicated to the flowmeters for hot and cold sanitary water.

The calculation unit is compatible with flowmeters with pulse output OC (open collector) or OA (reed), with pulse value “liters/pulse” (strictly compliant to the value set on the calculator).

Terminals 53 and 56 are reserved for eventual Anti-tampering wire connection.

Warning: when using flow meters with Open-Collector (OC) output, it is necessary to follow the correct connection polarity.











					
51	52	53	54	55	56
+	-	A	+	-	A
					
					

PULSE OUTPUT CONNECTIONS

The calculator is equipped with two Open-Collector pulse outputs (30V):

- refrigeration units output: cold OUT (57, 58)
- heating units output: hot OUT (16, 17)

These outputs can be connected to a compatible totalizer or to a signal converter.

			
57	58	16	17
+	-	+	-
cold OUT		hot OUT	
			
			
			

M-BUS NETWORK CONNECTION

The inputs/outputs "M-Bus" (24 and 25) are dedicated to the calculator connection with an M-Bus network cable.

For the connection is not necessary to respect the polarity, although it is advisable to keep the same polarity on the entire cable network.

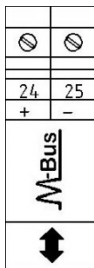

Warning: the M-Bus network is using voltage that can damage the device when applied to terminals dedicated to other functions, so be careful when connecting to this interface.

AUX POWER SUPPLY CONNECTION

The terminals 59 and 60 (Aux Power) are dedicated to the connection of the calculation unit to an external electric network by using a power adapter (3.6 ÷ 5 VDC, 300 mA) provided as an accessory.

When connected to the power supply, the battery will be used as backup power source.

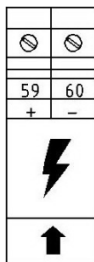

MASUREMENTS REPRESENTATION

The representation format of the measurements of the energy/power and volume/flow rate is determined basing on the pulse value "k" set up directly on the configuration.

The pulse value also determines the maximum power that, in accordance with standard EN1434-2, must be:

- $k < 10$: representation of energy consumption with 5 integers and 3 decimal 00000,000 MWh (GJ)
- $10 < k < 100$: representation of energy consumption with 6 integers and 2 decimal 000000.00 MWh (GJ)
- $k \geq 100$: representation of energy consumption with 7 integers and one decimal 0000000.0 MWh (GJ)

Warning: after the input pulse value of the flow sensor has been set, it is no longer possible to change it. It is important to plan carefully the parameter before commissioning.

COMMUNICATION INTERFACES

HEATING/COOLING PULSE OUTPUT INTERFACE

The pulse outputs (Open Collector - 30V), when connected to suitable totalizers compatible, allow the remote reading of heating and refrigeration units consumption.

The calculation unit is equipped with a pulse output dedicated for heating units (16, 17) and one dedicated to the refrigeration units (57, 58).

M-BUS INTERFACE

The Wired M-Bus communication interface, allows the remote reading by using the appropriate M-Bus Masters, EN13757 (Parts 2 and 3) approved.

The communication with the calculation unit can take place through a research by secondary address (serial number of the calculator) or by primary address (configurable in the menu).

For the M-Bus system instructions, refer to the corresponding manuals.

FUNCTIONALITY

The calculation unit **HYDROSPPLIT M-3** is equipped with dedicated sections for the thermal energy measurement of a heating/cooling system and for the volume measurement of the hot/cold sanitary water system.

The calculation unit is suitable for two-pipe domestic systems, in boiler room installations or any other compatible application.

In residential systems, usually two pipes systems, the measurement of the thermal energy takes place on a single section, both in heating and cooling cycle.

The picture below reports a typical connection diagram.

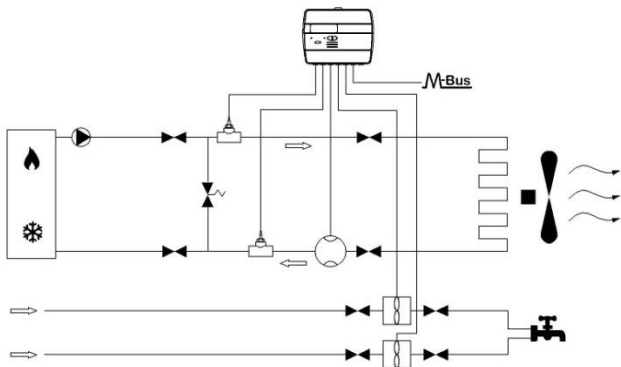

DISPLAY AND BUTTONS

The calculator is equipped in the front with a liquid crystal display and two buttons (T1 and T2), useful for the configuration of the parameters and for the readings.

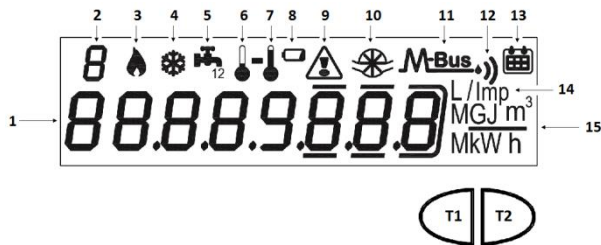

- 1) Eight-digit numeric field;
- 2) Single-digit numeric index (menu level);
- 3) Heating data index;
- 4) Cooling data index;
- 5) Circuits 1-2 for hot/cold sanitary water index;

- 6) Return flow temperature index;
- 7) Inlet flow temperature index;
- 8) Battery level indicator;
- 9) Faults indicator;
- 10) Heating system flowmeter index;
- 11) Wired M-Bus data index;
- 11+12) Wireless M-Bus data index (predisposition);
- 13) Historical data index;
- 14) Pulse value index (k);
- 15) Measurement unit index;
- T1) Level selection button;
- T2) scroll button within the selected level;

PROGRAMMING MENU

The programming menu is useful for the ordinary programming of the calculation unit and for configured data verification.

PROGRAMMING MENU ACCESS

To enter the programming menu, press the T1 button and select level 3. Then keep the T2 button pressed for more than 3 seconds.

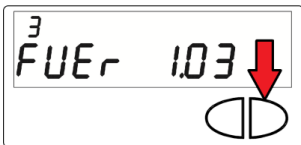

Once this is done, you will be prompted to enter a password for security reasons. Select the digit using the T2 button and change the single numbers with the T1 button.

The password is communicated by the manufacturer to the installer only.



After entering the password, it is possible to start the parameters configuration.

The configuration screens are divided into 15 sub-levels. Here below there is a “step by step” guide for the correct configuration of the calculation unit:

- 1) The first parameter to be configured is the pulse value "k" of the heating system flowmeter.

The value can be selected by using the button T1: 0.1–0.25–1–2.5–10–25–100–250 L/imp

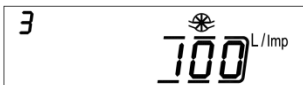

Confirm the selected parameter by holding the T2 button for more than 3 seconds, thus moving to the next parameter.

Warning: the pulse value "k" of the heating system flowmeter is settable only once. Once the configuration is confirmed, this parameter is no longer editable.

2) The second parameter that has been configured is the enabling/disabling of the anti-tampering contact of the heating system flowmeter (Flow in).

By using the T1 button, proceed with the enabling [1] or disabling [0].

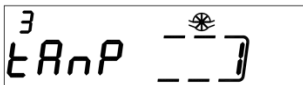

Confirm the selected parameter by holding the T2 button for more than 3 seconds, thus moving to the next parameter. The enabling of the anti-tampering system requires the connection of a normally closed (NC) contact between terminals 50 and 11. If the contact is opened, a fraud will be recorded.

3) The third parameter that has been configured is the pulse value "k" of the C1 cold/hot water meter.

The value can be selected by using the button T1: 0.1–0.25–1–2.5–10–25–100–250 L/imp

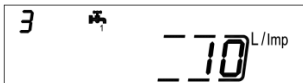

Confirm the selected parameter by holding the T2 button for more than 3 seconds, thus moving to the next parameter.

4) The fourth parameter that has been configured is the update of the consumption data reported on the C1 hot/cold water meter dial. Select the digit using the T2 button and change the single numbers with the T1 button.

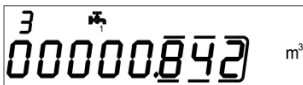

Confirm the selected parameter by holding the T2 button for more than 3 seconds, thus moving to the next parameter.

5) The fifth parameter that has been configured is the enabling/disabling of the anti-tampering contact of the C1 cold/hot water meter. By using the T1 button, proceed with the enabling [1] or disabling [0].

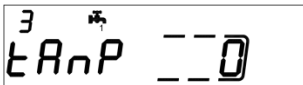

Confirm the selected parameter by holding the T2 button for more than 3 seconds, thus moving to the next parameter.

6) The sixth parameter that has been configured is the pulse value "k" of the C2 cold/hot water meter.

The value can be selected by using the button T1: 0.1–0.25–1–2.5–10–25–100–250 L/imp

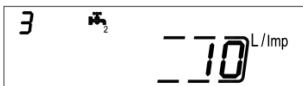

Confirm the selected parameter by holding the T2 button for more than 3 seconds, thus moving to the next parameter.

7) The seventh parameter that has been configured is the update of the consumption data reported on the C2 hot/cold water meter dial. Select the digit using the T2 button and change the single numbers with the T1 button.

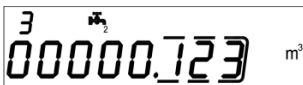

Confirm the selected parameter by holding the T2 button for more than 3 seconds, thus moving to the next parameter.

8) The eighth parameter that has been configured is the enabling/disabling of the anti-tampering contact of the C2 cold/hot water meter. By using the T1 button, proceed with the enabling [1] or disabling [0].

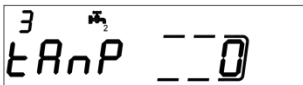

Confirm the selected parameter by holding the T2 button for more than 3 seconds, thus moving to the next parameter.

9) The ninth parameter that has been configured is the pulse value "k" of the OC pulse heating output (hot out). The value can be selected by using the button T1: 0 - 1 - 10 - 100 - 1000 kWh/imp

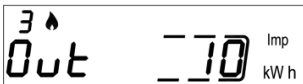

Confirm the selected parameter by holding the T2 button for more than 3 seconds, thus moving to the next parameter.

10) The tenth parameter that has been configured is the pulse value "k" of the OC pulse cooling output (cold out). The value can be selected by using the button T1: 0 - 1 - 10 - 100 - 1000 kWh/imp

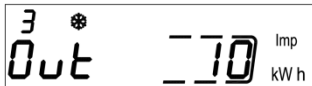

Confirm the selected parameter by holding the T2 button for more than 3 seconds, thus moving to the next parameter.

11) The eleventh parameter that has been configured is the secondary address of the Wired M-Bus (M-Bus) of the heating data. Select the digit using the T2 button and change the single numbers with the T1 button.



Confirm the selected parameter by holding the T2 button for more than 3 seconds, thus moving to the next parameter.

12) The twelfth parameter that has been configured is the primary address of the Wired M-Bus (M-Bus) of the heating data. Select the digit using the T2 button and change the single numbers with the T1 button.



Confirm the selected parameter by holding the T2 button for more than 3 seconds, thus moving to the next parameter.

13) The thirteenth parameter that has been configured is the secondary address of the Wired M-Bus (M-Bus) of the cooling data. Select the digit using the T2 button and change the single numbers with the T1 button.



Confirm the selected parameter by holding the T2 button for more than 3 seconds, thus moving to the next parameter.

14) The fourteenth parameter that has been configured is the primary address of the Wired M-Bus (M-Bus) of the cooling data. Select the digit using the T2 button and change the single numbers with the T1 button.



Confirm the selected parameter by holding the T2 button for more than 3 seconds, thus moving to the next parameter.

15) Finally to exit the menu and save the configured parameters, select the number [1] in the ESC panel by using the button T1. On the contrary, select the number [0] to return to the first sublevel

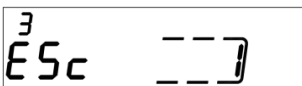

Warning: before confirming the settings saving, make sure to properly set all parameters, in particular the input pulse value of the flow sensor as it is no longer editable.

CONSULTING MENU

The consulting menu is divided in six levels by a numeric index, always shown in the left-upper part of the display.

By pressing the T1 button it is possible to choose the desired level, and by pressing the T2 button it is possible to consult the sublevels of the preset level.

Here below, it is shown the navigation map of the consulting menu.

LEVEL 1: CUMULATIVE VALUES

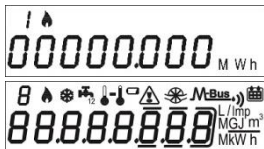

1.1 Accounted energy (Heating) – cumulative value

1.2 Display test – All segments on



1.3 Display test – All segments off



1.4 Accounted energy (cooling) – cumulative value



1.5 Volume useful for the accounting (heating) – cumulative value



1.6 Volume useful for the accounting (cooling) – cumulative value



1.7 Total volume (first pulse input - C1) – cumulative value (optional)



1.8 Total volume (second pulse input – C2) – cumulative value (optional)

LEVEL 2: ACTUAL ACCOUNTING VALUES



2.1 Actual power



2.2 Actual flow rate



2.3 Inlet flow temperature



2.4 Return flow temperature

2  016.5 C

2.5 Temperature difference

LEVEL 3: SETTINGS (DISPLAYING ONLY)

3 01234567

3.1 Serial number

3 FUEr 1.03

3.2 Firmware version

3 AUEr 1.02

3.3 Communication Firmware version

3 23.03.14 

3.4 Current Date

3  L/imp
1

3.5 Liters/pulse value for input flow sensor (flow in)

3   Unit 0 MWh

3.6 Measurement unit (0= Mwh, 1= GJ)

3  tAnP 1

3.7 Input flow sensor (Flow in) anti-tampering activated/deactivated

3  L/imp
0.1

3.8 Liters/pulse value for first input flow meter (C1)

3  m³
00000.100

3.9 Starting value first input flow meter (C1)

3 
tAnP 0

3.10 Input flow meter (C1) anti-tampering activated/deactivated

3 
0.1 L/imp

3.11 Liters/pulse value for second input flow meter (C2)

3 
00000.177 m³

3.12 Starting value second input flow meter (C2)

3 
tAnP 1

3.13 Input flow meter (C2) anti-tampering activated/deactivated

3 
Out 10 imp
kW h

3.14 Liters/pulse value for heating pulse output (Hot out)

3 
Out 1 imp
kW h

3.15 Liters/pulse value for cooling pulse output (Cold out)

3 
140000008 M-Bus

3.16 M-Bus Secondary address (Heating)

3 
bus 001 M-Bus

3.17 M-Bus Primary address (Heating)

3 
940000001 M-Bus

3.18 M-Bus Secondary address (Cooling)

3 
bus 002 M-Bus

3.19 M-Bus Primary address (Cooling)

LEVEL 3: SETTINGS (CONFIGURATION)

The setting of the parameters can be enabled by pressing T2 for 3 seconds while viewing one of the points of the level 3.



3s.1 Password request to enable parameters setting

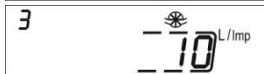

3s.2 Liters/pulse value setting for input flow sensor (flow in)

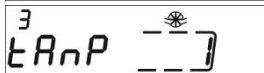

3s.3 Input flow sensor (Flow in) anti-tampering activated/deactivated setting



3s.4 Liters/pulse value setting for first input flow meter (C1)



3s.5 Starting value setting for first input flow meter (C1)

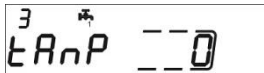

3s.6 Input flow meter (C1) anti-tampering activated/deactivated setting



3s.7 Liters/pulse value setting for second input flow meter (C2)



3s.8 Starting value setting for second input flow meter (C2)

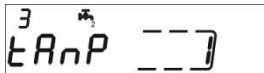

3s.9 Input flow meter (C2) anti-tampering activated/deactivated setting



3s.10 Liters/pulse value setting for heating pulse output (Hot out)

3 * 00t 10 imp kWh

3s.11 Liters/pulse value for cooling pulse output (Cold out)

3 ^ M-Bus 14000000

3s.12 M-Bus Secondary address setting (Heating)

3 ^ M-Bus bus 00

3s.13 M-Bus Primary address setting (Heating)

3 * M-Bus 94000000

3s.14 M-Bus Secondary address setting (Cooling)

3 * M-Bus bus 002

3s.15 M-Bus Primary address setting (Cooling)

3 Esc 0

3s.16 Saving parameters settings and exit
1 = save and exit, 0 = don't exit

LEVEL 4: MEMORY DAY DATA

4 2303.14

4.1 Memory Day

4 ^ 000000003 MWh

4.2 Accounted Energy (heating) – cumulative value at memory day

4 * 000000003 MWh

4.3 Accounted Energy (cooling) – cumulative value at memory day

4 ^ 0000 1.302 m³

4.4 Accounted Volume (C1) – accounted volume at memory day (optional)



4.5 Accounted Volume (C2) – accounted volume at memory day (optional)

Memory day setting:

- View any of the points in the level 4
- Press and hold T2 button for 3 seconds.
- The setting screen will be displayed.
- Enter the desired date in the gg.mm format (T1 - digit increase, T2 - selection digit).
- Confirm the setting by pressing and holding the T2 button for 3 seconds.

LEVEL 5: HISTORICAL DATA



5.1 Total operation hours during calculation



5.2 Total lifetime hours



5.3 Historical data storage (up to 26 possible values, saving at the end of the month)



5.3.1 Accounted Energy (heating) – cumulative value at historical memory day



5.3.2 Accounted Energy (cooling) – cumulative value at historical memory day



5.3.3 Accounted Volume (C1) – accounted volume at historical memory day (optional)



5.3.4 Accounted Volume (C2) – accounted volume at historical memory day (optional)

LEVEL 6: ERRORS AND FAULTS



5.1 Functioning hours during error



5.2 Active error list



5.3 Number of accesses with installer password



5.3.1 Date of last modified setup parameters

COMMISSIONING

Premise: the procedures explained in this paragraph must be carried out only after the conclusion of the installation phases, the connection procedures and after the testing of the hot/cold water and heating/cooling systems.

Warning: once the calculation unit has accounted energy and volumes, some of the settable parameters will no longer be editable. It is important to set all parameters carefully before the final commissioning.

COMMISSIONING PROCEDURE

- 1) Ensure that the electrical wirings are carried out correctly;
- 2) Check in the level 3 that all parameters are correctly set on the calculator (especially the pulse value for the flow sensor –flow in-);
- 3) Verify that the flowmeters and volume meters, the temperature sensors etc. are installed correctly. (always refer to the installation manuals specific to every product)
- 4) Start the heating system:
 - Check if the registered values are coherent (inlet/return temp.)
 - Check the totalized volume and current flowrate;
- 5) Start the hot/cold sanitary water system:
 - Check if the registered values are coherent (volume)
- 6) Check that no error is active.
- 7) Apply eventual adhesive or lead sealings.

ERRORS AND FAULTS

when one or more anomalies occur, the calculation unit will signal the recorded error and will display the following icon: .

The log of all faults is shown at level 6 of the consulting menu, where the abbreviation *Err* followed by three digits identifies the anomaly.

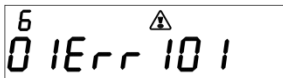

Here is a list of all the error codes:

Error	Description	Prescription	Notes
Err101	One of the two temperature sensor cables is cut; At least one cable is disconnected	Check the integrity and the connection of the temperature sensor cables.	The alarm automatically resets when the issue is solved.
Err102	One of two temperature sensor measurement out of range; at least one sensor is damaged. The error resets after the sensor replacement.	Check the integrity and the functioning of the temperature sensors.	The alarm automatically resets when the issue is solved.
Err103	Reading/writing error; Memory of historical data damaged.	Return the device to the manufacturer.	
Err104	Calendar Error (time bases corrupted); Faulty time bases oscillator.	Return the device to the manufacturer.	
Err105	MBUS communication interface error	Return the device to the manufacturer.	The error doesn't affect the calculation unit correct measurement.
Err106	Reserved		
Err107	Loss of power supply	Return the device to the manufacturer for repairing	
Err108	Electronics case opening	Return the device to the manufacturer for repairing	
Err201	Reserved		
Err202	Reserved		
Err203	Battery life below 1 year	Return the device to the manufacturer.	
Err204	Reserved		
Err205	Fraud attempt pulse input of the flow sensor (flow in); Detected fraud on the alarm line from the pulse emitter device of the flow sensor (flow in)	Check connection cable between calculator and pulse emitter device.	
Err206	Fraud attempt pulse input of the volume meter (C1); Detected fraud on the alarm line from the pulse emitter device of the volume meter (C1)	Check connection cable between calculator and pulse emitter device.	
Err207	Fraud attempt pulse input of the volume meter (C2); Detected fraud on the alarm line from the pulse emitter device of the volume meter (C2)	Check connection cable between calculator and pulse emitter device.	
Err301	MBUS data exchange interactions limit reached	Wait 00:00 of the current day before sending additional data requests through MBUS interface	
Err302	Reserved		

BATTERY AND REPLACEMENT PROCEDURES

The calculation unit constantly checks the battery status (average lifetime: 10 years) and signals the imminent discharge showing the icon  on the display. The signal will be shown one year before the complete discharge.



For the replacement, contact the manufacturer.

Warning: the calculation unit is equipped with non-rechargeable batteries, that can be dangerous when used improperly. In order to reduce the risks, it is necessary to respect the following precautions:

- Don't recharge the battery;
- Don't put the battery in short circuit;
- Don't expose the battery at temperatures higher than 85°C.
- Don't use open flames near the calculation unit
- Don't let the calculator make contact with water
- Always dispose the batteries in compliance with current regulations
- Always use original spare parts authorized by the manufacturer.

CALCULATION UNIT DATA SHEET

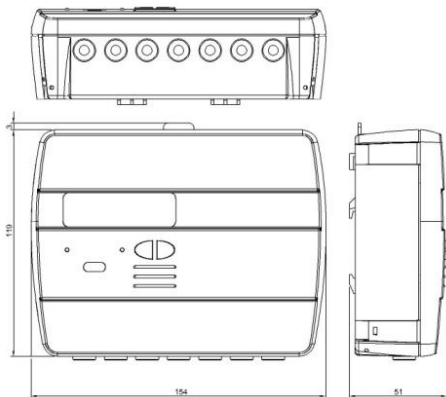

Model	Hydrosplit M3
Power supply	-Battery supply -Electrical supply (optional, 3.6 ÷ 5 VDC, 300 mA): in this case, the battery will be used as backup power supply)
Battery type	Li-SoCl ₂ Lithium-thionyl chloride, 3,6V "size D" 20Ah
Battery Life	10 years +1
Operating temperature range	5 ÷ 55°C
Storage temperature range	-10 ÷ 55°C
Dimensions	154 x 119 x 51mm
IP protection grade	IP52
Approval	2004/22/CE MID (Module B) Certificate nr.IT-MI004-xxxx EN1434
Environmental class	A (E1, M1)
Temperature measurement range, MID approved (heating applications)	Θ: 5÷180°C
Temperature difference range, MID approved (heating applications)	ΔΘ: 3÷150K
Temperature measurement range (cooling)	Θ: 2÷24°C
Temperature difference range (cooling)	ΔΘ: 3÷20K

Operative counting conditions	Heating: $\Delta\theta \geq 1\text{K}$ and fluid temperature $\geq 5^\circ\text{C}$ (accounting enabling conditions) Cooling: $\Delta\theta \leq 0.2\text{K}$ and fluid temperature $\leq 24^\circ\text{C}$
Maximum measurable power	99 MW
Maximum measurable flowrate	2000 m ³ /h
Display	LCD, 8 digits + icons
Measurement unit	MWh (standard), GJ (optional)
Temperature sensors	Pt1000 (two-wired)
Cable length	3 m
Pulse inputs	1 dedicated for the heating circuit flow meter 2 dedicated for the cold/hot sanitary water volume meter
Pulse input class	Class IA (default): Open Collector or electromagnetic contact (reed), max 5Hz
Pulse input maximum frequency (MID approved)	5 Hz
Maximum length pulse emitter cable	3 m
Installation site of flowmeter (Flow in)	Return flow pipe (Default), Inlet flow pipe (optional). Always refer to the indication on the cover of the calculator.
Supported vector fluid	Water

FUNCTIONING BEYOND THE LIMITATIONS DECLARED

It is recommended to ensure that the measurement conditions are within the exposed limits of certification. The unit doesn't disable the functioning outside these ranges, its use is not covered by the certification if the measurement conditions don't meet the certification validity conditions.

Regarding the flow measurement conditions of the flow sensor connected to the calculator, always respect of the flow rates recommended in the table here below depending on the factor of the flow sensor.

Flow sensor (Flow In) pulse value [liter\imp]	Max. allowed flow rate [m3\h]	Min. recommended flowrate [m3\h]
0,1	1,8	0,010
0,25	4,5	0,025
1	18	0,1
2,5	45	0,250
10	180	1
25	450	2,5
100	1800	10
250	2000	25