

# mod. Hydrosonis-ULC

**i** **Note:** In the text below, the term meter refers both to the heat meter and to the cooling meter and the combined heat and cooling meter, unless otherwise specified.

## 1. General

### 1.1 Use

The HYDROSONIS-ULC is used as a meter for heating or cooling consumption measurement in systems with water. The meter consists of a volume measurement unit, two fixed temperature sensors and an electronic unit that calculates the energy consumption based on volume and temperature difference.

**i** **Note:** The meter cannot be opened without damaging the security seal.

### 1.2 General notes

The meter left the factory in a faultless condition where safety is concerned. The manufacturer will provide additional technical support on request. Calibration relevant security seals on the meter must not be damaged or removed. Otherwise, the warranty and calibration validity of the meter will no longer apply.

- Keep the packaging so that you can transport the meter in its original packaging following expiry of the calibration validity.
- Lay all cables at a minimum distance of 500 mm to high voltage and high frequency cables.
- A relative humidity of < 93 % at 25 °C is permissible (without condensation).
- Avoid cavitation in the whole system due to overpressure i.e. at least 1 bar at qp and approx. 2 bar at qs (applies for approx. 80 °C).

### • Safety informations

- !** The meters may only be used in building service engineering plants and only for the applications described.
- !** The local regulations (installation etc.) must be adhered to.
- !** The operating conditions according to the type plate must be complied with during use. Non-compliance can result in hazardous situations and the expiry of all claims arising from liability for defects as well as liability on the basis of any expressly granted guarantees.
- !** The meter is only suitable for circulating water in heating systems.
- !** The meter is not suitable for drinking water.
- !** Beware of sharp edges on thread, flange and measuring section.
- !** Requirements for circulating water (CEN/TR 16911: 2016).
- !** Only personnel, trained in the installation and operation of meters in heating and cooling systems, may install and remove the meter.



Only install or remove the meter when the pipes are pressure-less.



After installing the meter, check the leak-tightness of the system.



Guarantee and calibration validity will lapse if the calibration relevant security seal is broken.



Only clean the meter from outside with a soft, lightly wetted cloth. Do not use any spirit or cleaning solvent.



As far as disposal is concerned, the meter is a waste electronic appliance in the sense of European Directive 2012/19/EU (WEEE) and it must not be disposed of as domestic waste. The relevant national, legal regulations must be observed as the appliance must be disposed of via the channels provided for this purpose. The local and currently valid legislation must be observed.



The meter contains lithium batteries. Do not dispose of the meter and the batteries with domestic waste. Observe the local stipulations and laws on disposal.



You can return the lithium batteries to the manufacturer for appropriate disposal following use. When shipping please observe legal regulations, in particular, those governing the labelling and packaging of hazardous goods.



Do not open the batteries. Do not bring batteries into contact with water or expose to temperatures above 80 °C.





The meter does not have any lightning protection. Ensure lightning protection via the in-house installation.

## 3. Installation



To install the meter proceed as follows:

- Determine the place of installation in line with the inscription on the meter.



**Note:** At a heating meter  or combined heat/cold meter the mounting place of the flow sensor cold side is equivalent to return . The mounting place of the flow sensor hot side is equivalent to flow .



**Note:** At a cooling meter  the mounting place of the flow sensor hot side is equivalent to the return . The mounting place of the flow sensor cold side is equivalent to flow .

- Observe the dimensions of the meter and check whether there is sufficient space available.
- Rinse the system thoroughly before installing the meter.
- Fit the meter vertically or horizontally between two slide valves so that the arrow on the housing and the flow direction match. Also observe the installation situations and the following examples of installation.
- Fit the temperature sensors in the same circuit as the meter. Please observe admixtures.

- Seal the temperature sensor and the fittings to protect against manipulation.
- If you install the meter for cooling metering, follow the appropriate notes.

**Recommendation:** If you are installing several meters, the same installation conditions must be consistent for all meters.

#### Installation notes

**Note:** When installing the meter, the locally applicable installation regulations for meters must be observed.

Inlet or outlet sections are not necessary. If you install the meter in the common return of two circuits, determine a place of installation with a minimum distance of  $10 \times DN$  from the T-piece. This distance ensures a good mixing of the different water temperatures. You can install the temperature sensors in T-pieces, ball valves, directly immersed or in pockets depending on the version. The temperature sensor ends must reach to at least the middle of the pipe cross section.

**Note:** Protect the meter against damage through impacts or vibrations at the place of installation.

**Note:** Ensure the electronic unit is protected against any ingress of water.

**Recommendation:** Do not install the meter on the intake side of a pump. Maintain a minimum distance of  $10 \times DN$  on the outlet side.

#### Examples of installation (directly immersed sensor)

You can install the meter in any position e.g. vertically or horizontally. In order to avoid accumulation of air and disruption in operation, fit the meter in a vertical installation position and not in the uppermost area of a pipeline.

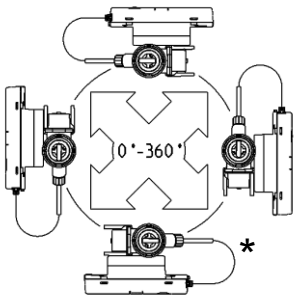

\* This position is not permitted for cold meters and in cases where moisture can enter the electronic unit due to condensation (e.g. during an interruption in the summer).

Fig. 1

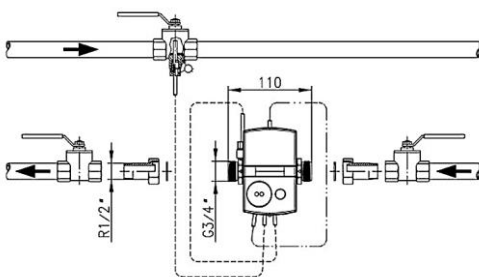

Fig. 2: Example for installation with ball valve and meter with 110 mm armature

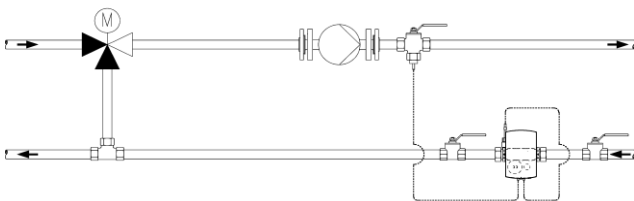

Fig. 3: Installation for circulation with admixing; placement of temperature sensors

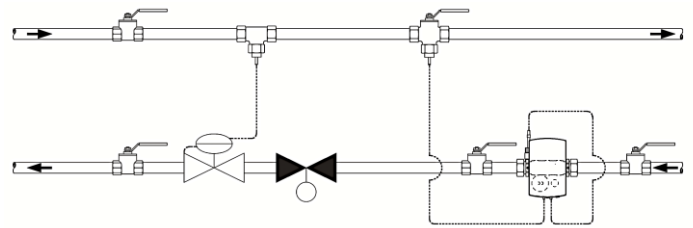

Fig. 4: Installation for circulation with throttling configuration for example (flow sensor in flow direction before control valve / differential pressure regulating valve)

#### Installation notes for sensor adapter set

A mounting set is included for meters with  $5.2 \times 45$  mm temperature sensors. With this you can fit the temperature sensor directly immersed into an insert or a ball valve for example.

1. Use the fit-up aid/pen provided to mount the O-ring at the installation point.
2. Place both halves of the plastic bolting round the 3 notches of the temperature sensor.
3. Press the bolting together and screw the bolting hand tight into the installation point up to the stop (tightening torque 3 ... 5 Nm).

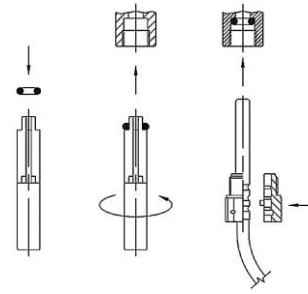

Fig. 5: Mounting adapter set

#### 3.1 Installation of cooling meters and combined heat/cooling meters

Observe the following installation instructions to avoid condensation water.

- Mount the cooling meter so that the black cover on the measuring section points sideways or downwards.
- Mount the electronic unit separated from the volume measuring unit e. g. on the wall.
- Form a loop downwards with the connected cables.
- Mount the protection pocket so that the temperature sensor stands vertically downwards or horizontally.
- Mount the temperature sensor horizontal or vertical in the pipe from below.

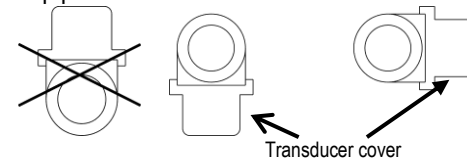

Fig. 6: Recommended mounting position for cooling measurement

#### 3.2 Electronic unit

The ambient temperature of the electronic unit must not exceed  $55^\circ\text{C}$ . Avoid direct sunlight.

Mount the electronic unit separated from the volume measurement unit e. g. on the wall if the water temperatures are below  $10^\circ\text{C}$  and above  $90^\circ\text{C}$ .

#### Aligning electronic unit

Proceed as follows to align the electronic unit:

- Turn the electronic unit to the left or right through  $90^\circ$  or through  $180^\circ$  as required.

**Note:** When turning through  $45^\circ$  the electronic unit is not connected tightly to the volume measurement unit.

Wall fitting (split fitting)

Proceed as follows for the wall fitting:

- Turn the electronic unit through 45°.
- Pull the electronic unit away from the volume measurement unit.
- Unscrew the adapter plate from the volume measuring unit.
- Fix the adapter plate on the wall.

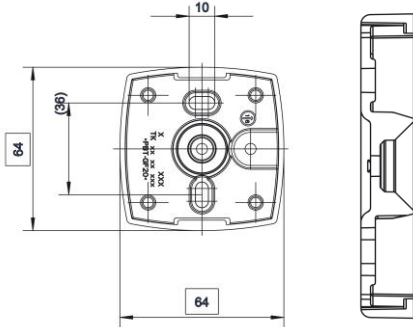

Fig. 7: Top view and cross section of the adapter plate

- Place the electronic unit on the wall adapter at an angle of 45° and turn it into position.

3.3 Power supply

The meter is equipped with a long life battery for 6 or 11 years of operation. You can find the operating time on the dial plate.

**Warning:** Do not open the batteries. Do not bring battery into contact with water or expose to temperatures above 80 °C. Dispose of used batteries at suitable collection points.

3.4 Interfaces and Communication

**Note:** Frequently switching off the M-bus voltage may result in a reduction of the battery life.

The meter is equipped with an optical interface in accordance with EN 62056-21 as standard.

If the meter is equipped with the option "M-Bus", it is supplied with a 2-wire cable.

If the meter is equipped with the option "pulse", it is supplied with a 4-wire cable.

The connection cable can be extended by fitting a junction box.

3.5 Temperature sensor

**Note:** Wires must not be separated, shortened or extended.

4. Operating

**Note:** Both display range and data displayed can differ from this description depending on the appliance parameterization. Certain button functions can also be blocked.

The meter consists of a 7-digit LCD displaying various values.

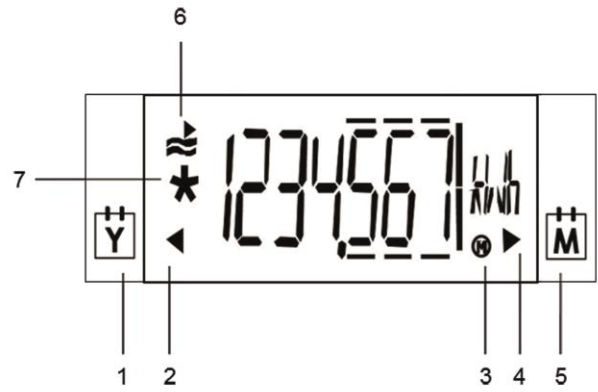

Fig. 8: LCD

Number	Description
1	Identification previous year value
2	Previous year value
3	Maxima
4	Previous month value
5	Identification previous month value
6	Activity display at flow
7	Calibrated value

Switching the display

Proceed as follows to switch between the display values:

- Press the button briefly (for less than 2 sec.) to show the next line of the current loop.

After the last line is displayed, the first line comes up again.

- Hold down the button (longer than 3 sec.) in order to display the next loop.

After the last loop is displayed, the first loop comes up again.

If you do not operate the meter for 30 sec. in the user loop "LOOP 0", the meter changes to the standard display. If you do not operate the meter for 30 min. in the loops "LOOP 1 ... 4", the meter changes to the standard display.

User loop "LOOP 0"

LOOP 0	User loop	Segment test
*1234567 kWh	Energy quantity	In case of error message with error code
1234567 kWh	Cooling registers (optional)	
col d		
*1234567 m³	Volume	

Current values "LOOP 1"

LOOP 1	Current values	Temperature difference
1234 kWh	Current flow	Operating time with flow
300 kWh	Current heat power	Missing time
670 °C	Alternate current temperature hot and cold side in 2 s cycles	Time with flow
460 °C		

Previous month's values "LOOP 2"

LOOP 2	Previous month's values		
0102.12	Log date	1000	Max. power in 2 s cycles with date stamp
1234567	Amount of energy on set day	1702.12	
1234567	Cooling registers on set day (optional)	810	Max. temperature hot side in 2 s cycles with date stamp
cold	Volume on set day	1702.12	
1234567	Missing time on set day	660	Max. temperature cold side in 2 s cycles with date stamp
Fd 123	Max. flow on set day in 2 s cycles with date stamp	1702.12	
3099			
1701.12			

General/Communication "LOOP 3"

LOOP 3	General/Communication		
1234567	Device number, 7-digit	0101--	Yearly set day
M-Bus	Optional interface	01---M1	Monthly set day
127	Primary address (only for M-Bus)	17-16	Firmware version
0000000	Secondary address 7-digit - for M-Bus	67E05	CRC-Code

Other "LOOP 4"

LOOP 4	Other		
0802.12	Date	----	Code entry for test / para operation
105959	Time		

4.1 Monthly values

The meter stores the following values for 24 months on the monthly set day

- Missing time
  - Volume
  - Energy
- and the maxima with date stamp for
- Flow
  - Power
  - Temperature hot side
  - Temperature cold side

4.2 Parameterization

When the LCD displays the code input, you can access the parameterization operation by entering the code. You can set date and M-Bus primary address in the parameterization operation for example. For more detail see the separate parameterization instruction.

5. Getting started

For activation proceed as follows:

- Open the slide valves slowly.
- Check the heating system for leak-tightness.
- Vent the heating system carefully.
- Press the button on the meter briefly.

The message "F0" disappears after 10 sec.

- Check the measured values for flow and temperatures for plausibility.

- If needed vent the heating system until the flow display is stable.
- Fit the user locks to the fittings and the temperature sensors. The scope of supply includes two self lock seals for sealing a sensor and the connecting fitting.
- Read the meter status for energy, volume, operation and missing time and note the values.

Error messages for incorrect installation:

FL nEE	<b>Error "incorrect flow direction (negative)"</b> Check that the flow direction arrows on the volume measurement unit match the flow direction of the system. If the directions do not match, turn the volume measurement unit by 180°.
dIFFnEE	<b>Error "negative temperature difference"</b> Check whether the sensors are installed in the right circular flow (flow and return flow interchanged). Use only a meter suitable to the mounting place. <b>Heat meter:</b> Temperature sensor in the flow-pipe with higher temperatures; temperature sensor in return-pipe with lower temperature <b>Cooling meter:</b> Temperature sensor in the flow-pipe with lower temperatures; temperature sensor in return-pipe with higher temperature

6. Functional details

If the respective operation thresholds are exceeded and flow and temperature difference are positive, the meter summates the energy and the volume.

If the operate margin is gone below a "u" is displayed at a leading point for the flow, power and temperature display.

For a positive flow the activity display  appears in the user loop in the LCD.

All segments of the display are switched on for control purposes during the segment test. The flow, power and temperature difference are recorded with the appropriate +/- signs.

The operating hours are counted from the first connection of the power supply. The meter saves "operating time with flow" as soon as a positive flow is recognized. Missing hours are summated if there is a fault and the meter is thus unable to take a measurement.

Stored maximum values are marked with an „M“ in the lower right hand area of the LCD.

## 7. Error codes

The meter continuously runs a self-diagnosis and can thus recognize and display various installation or meter errors:

Error code	Error	Service guidelines
FL nEG	Incorrect flow direction	Check flow or installation direction; correct if necessary
<b>if necessary in exchange with:</b>		
DIFF nEG	Negative temperature difference	Check installation point of the temperature sensors; exchange if necessary
<b>if necessary in exchange with:</b>		
F0	No flow can be measured	Air in the measurement unit/pipe, bleed air from pipe (delivery condition)
F1	Interruption in the hot side temperature sensor	Inform service department
F2	Interruption in cold side temperature sensor	Inform service department
F3	Electronics for temperature evaluation defective	Inform service department
F4	Battery flat	Inform service department
F5	Short-circuit hot side temperature sensor	Inform service department
F6	Short-circuit cold side temperature sensor	Inform service department
F7	Error in the internal memory holding	Inform service department
F8	Errors F1, F2, F3, F5 or F6 for longer than 8 hours, recognition of attempts to manipulate.	Measure dependent on error code. Error message F8 must be reset by service department.
F9	Error in the electronics	Inform service department

## Power Supply

Type of power supply	Battery for 6 or 11 years
Battery type	AA cell lithium
Lithium content	0,65 g per battery
Number of batteries	1 – 3, depending on the configuration

qp m <sup>3</sup> /h	Overall length and connection		
0.6	110 mm (3/4 ")		190 mm (1 ")
1.5	110 mm (3/4 ")	130 mm (1 ")	190 mm (1 ")
2.5		130 mm (1 ")	190 mm (1 ")

## 8. Technical data



**Note:** The information on the meter must be observed!

### General

Measuring accuracy	Class 2 or 3 (EN 1434)
Environment class	A (EN 1434) for indoor installation
Mechanical class	M1 / M2 *)
Electromagnetic class	E1 *)
*) according to 2014/32/EU Directive on Measuring Instruments	
Ambient humidity	< 93% rel. humidity at 25 °C, without condensation
Max. height	2000 m above sea level
Storage temperature	- 20 ... 60 °C

### Electronic unit

Ambient temperature	5 ... 55 °C
Housing protection rating	IP 54 according to EN 60529
Power supply	Battery for 6 or 11 years
Operation threshold f. ΔT	0.2 K
Temperature difference ΔT	3 K ... 80 K
Temperature measurement range	0 ... 180 °C
LCD	7 digit
Optical interface	Standard, EN 62056-21
Communication	Optional
Separability	Always, cable length 1.5 m

### Temperature sensor

Type	Pt 500 according to EN 60751, not detachable
Connection type	Pt 500, 2 wire technology
Cable length	1.5 m
Construction type	Bolb sensor ø 5.2 × 45 mm; DS direct short, M10 × 27,5 mm
Temperature range	0 ... 105 °C

### Volume measuring unit

Protection class	IP 54 according to EN 60529; optional IP 65
Mounting place	Hot side / cold side
Installation position	Any, horizontal or vertical
Flow straightening	None
Measuring range	1:100
Temperature range	5 ... 105 °C
	National type approvals may be different.
Maximum overload	qs = 2 x qp, permanent
Nominal pressure	PN16 (1.6 MPa; PS16) PN25 (2.5 MPa; PS25)